



PRESSURE SENSORS

Normally-On Single Stage Pressure Repeater



Normally-On Single Stage Pressure Repeater for off-on control of an adjustable reference pressure when a sensed pressure moves above or below the reference pressure level

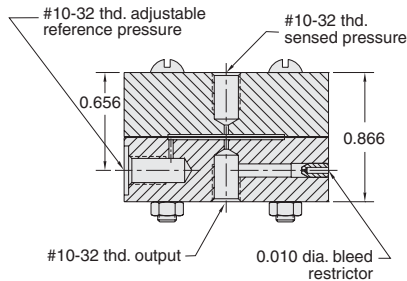
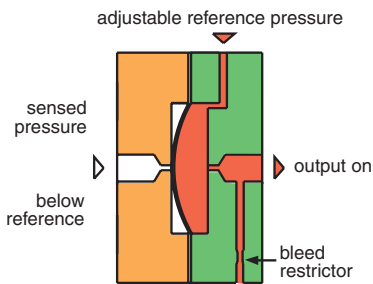
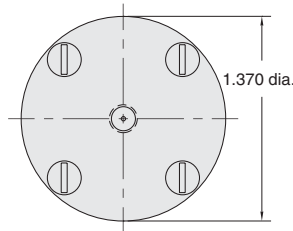

Medium: Reference pressure - air sensed pressure - Air, gas, or liquid

Input Pressure: 1 to 150 psig max.

Air Flow: 0.029" orifice

Response Time: 5 milliseconds

Differential Sensitivity: 2%

Frequency Response: 60 Hz

Materials: Anodized aluminum body, Buna-N diaphragms

Part No.	Description
1043	Single Stage Pressure Repeater

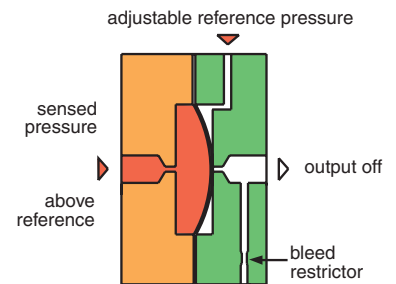

Normally-Off Two Stage Pressure Repeater



Normally Off Two Stage Pressure Repeater for off-on control of an adjustable reference pressure when a sensed pressure moves above or below the reference pressure level

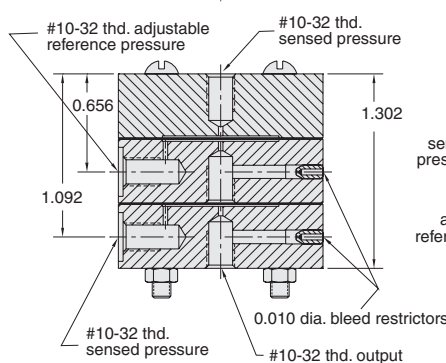
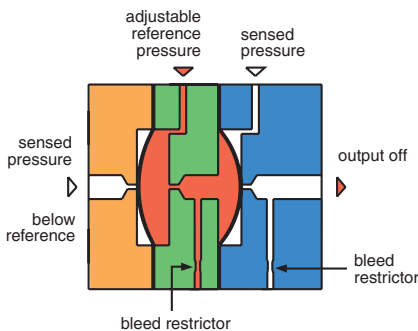
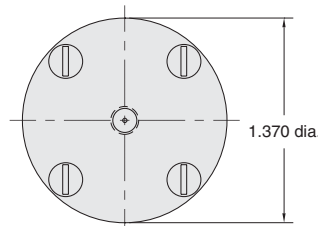

Medium: Reference pressure - air sensed pressure - Air, gas, or liquid

Input Pressure: 1 to 150 psig max.

Air Flow: 0.029" orifice

Response Time: 5 milliseconds

Differential Sensitivity: 2%

Frequency Response: 60 Hz

Materials: Anodized aluminum body, Buna-N diaphragms

Part No.	Description
1044	Two Stage Pressure Repeater

