



# PUSH-QUICK FITTINGS



## Fitting Type

- BC** - Bulkhead Connector
- BT** - Branch Tee
- BU** - Bulkhead Union
- CC** - Compact Male Conn.
- CU** - Cross Union
- EE** - Extended Elbow
- ER** - Elbow Reducer
- EU** - Elbow Union
- FC** - Female Connector
- FE** - Female Elbow
- MA** - Male Angle Connector
- MC** - Male Connector
- ME** - Male Elbow
- MM** - Male Manifold
- MU** - Manifold Union
- PE** - Plug-In Elbow
- PG** - Plug
- RB** - Reduced Branch
- RT** - Run Tee

- RU** - Reduced Union
- SC** - Stem Coupler
- SE** - Stack Elbow
- SU** - Straight Union
- TU** - Tee Union
- TR** - Tube Reducer
- UE** - Universal Elbow
- YC** - Y Connector
- YU** - Y Union

## Tubing Size (O.D.)

- 04** - 1/8" (0.125")
- 04M** - 4 mm (0.157")
- 05** - 5/32" (0.156")
- 06M** - 6 mm (0.236")
- 08** - 1/4" (0.250")
- 08M** - 8 mm (0.313")
- 10** - 5/16" (0.313")
- 12** - 3/8" (0.375")
- 16** - 1/2" (0.500")

## Thread Size

- N** - #10-32
- 5** - M5 Thd.
- 6** - M6 Thd.
- P** - 1/8" NPT
- R** - R1/8
- Q** - 1/4" NPT
- 2** - R1/4
- W** - 3/8" NPT
- 3** - R3/8
- Z** - 1/2" NPT

## Threaded Fittings

Tube	Thread	Female Connector FC	Male Compact Connector CC	Male Connector MC	Female Elbow FE	Male Elbow ME	Extended Elbow EE	Run Tee RT
1/8"	#10-32 1/8" NPT 1/4" NPT		PQ-CC04N PQ-CC04P	PQ-MC04N PQ-MC04P PQ-MC04Q	PQ-FE04N PQ-FE04P	PQ-ME04N PQ-ME04P		
5/32"	#10-32 1/8" NPT 1/4" NPT	PQ-FC05N PQ-FC05P	PQ-CC05N PQ-CC05P	PQ-MC05N PQ-MC05P PQ-MC05Q	PQ-FE05N PQ-FE05P PQ-FE05Q	PQ-ME05N PQ-ME05P PQ-ME05Q	PQ-EE05N PQ-EE05P	PQ-RT05N PQ-RT05P
4 mm*	M5 thd. R1/8	PQ-FC04M5 PQ-FC04MR		PQ-MC04M5 PQ-MC04MR		PQ-ME04M5 PQ-ME04MR		PQ-RT04M5 PQ-RT04MR
6 mm*	M5 thd. R1/8 R1/4	PQ-FC06MR PQ-FC06M2		PQ-MC06M5 PQ-MC06MR PQ-MC06M2		PQ-ME06M5 PQ-ME06MR PQ-ME06M2		PQ-RT06M5 PQ-RT06MR PQ-RT06M2
1/4"	#10-32 1/8" NPT 1/4" NPT 3/8" NPT	PQ-FC08P PQ-FC08Q	PQ-CC08N PQ-CC08P PQ-CC08Q	PQ-MC08N PQ-MC08P PQ-MC08Q PQ-MC08W	PQ-FE08N PQ-FE08P PQ-FE08Q	PQ-ME08N PQ-ME08P PQ-ME08Q PQ-ME08W	PQ-EE08P PQ-EE08Q PQ-EE08W	PQ-RT08N PQ-RT08P PQ-RT08Q
5/16"	1/8" NPT 1/4" NPT 3/8" NPT	PQ-FC10P PQ-FC10Q PQ-FC10W		PQ-MC10P PQ-MC10Q PQ-MC10W	PQ-FE10P PQ-FE10Q	PQ-ME10P PQ-ME10Q PQ-ME10W	PQ-EE10P PQ-EE10Q PQ-EE10W	PQ-RT10P PQ-RT10Q PQ-RT10W
8 mm*	M5 R1/8 R1/4 R3/8	PQ-FC08MR PQ-FC08M2 PQ-FC08M3		PQ-MC08M5 PQ-MC08MR PQ-MC08M2 PQ-MC08M3		PQ-ME08MR PQ-ME08M2 PQ-ME08M3		PQ-RT08MR PQ-RT08M2 PQ-RT08M3
3/8"	1/8" NPT 1/4" NPT 3/8" NPT 1/2" NPT	PQ-FC12Q PQ-FC12W	PQ-CC12Q PQ-CC12W	PQ-MC12P PQ-MC12Q PQ-MC12W PQ-MC12Z	PQ-FE12Q PQ-FE12W	PQ-ME12P PQ-ME12Q PQ-ME12W PQ-ME12Z	PQ-EE12Q PQ-EE12W PQ-EE12Z	PQ-RT12P PQ-RT12Q PQ-RT12W
1/2"	1/4" NPT 3/8" NPT 1/2" NPT			PQ-MC16Q PQ-MC16W PQ-MC16Z		PQ-ME16Q PQ-ME16W PQ-ME16Z	PQ-EE16W PQ-EE16Z	







\* Fittings have a green release button.

Note: Fittings with pipe thread NPT, R1/8, R1/4 and R3/8 are supplied with pre-applied sealant.









# PUSH-QUICK FITTINGS

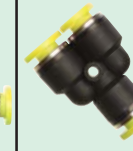

## Threaded Fittings Cont'd.

								
Tube	Thread	Branch T BT	Y Connector YC	Universal Elbow UE	Stack Elbow SE	Manifold Mount MM	Male Angle Connector MA	Bulkhead Connector BC
1/8"	#10-32 1/8" NPT		PQ-YC04N PQ-YC04P				PQ-MA04N PQ-MA04P	PQ-BC04P
5/32"	#10-32 1/8" NPT 1/4" NPT	PQ-BT05N PQ-BT05P	PQ-YC05N PQ-YC05P	PQ-UE05N PQ-UE05P	PQ-SE05N PQ-SE05P	PQ-MM0805P PQ-MM1005Q	PQ-MA05N PQ-MA05P	PQ-BC05P
4 mm*	M5 R1/8	PQ-BT04M5 PQ-BT04MR		PQ-UE04M5 PQ-UE04MR			PQ-MA04M5 PQ-MA04MR	PQ-BC04MR
6 mm*	M5 thd. R1/8 R1/4	PQ-BT06M5 PQ-BT06MR PQ-BT06M2		PQ-UE06M5 PQ-UE06MR PQ-UE06M2			PQ-MA06M5 PQ-MA06MR PQ-MA06M2	PQ-BC06MR PQ-BC06M2
1/4"	#10-32 1/8" NPT 1/4" NPT 3/8" NPT	PQ-BT08N PQ-BT08P PQ-BT08Q	PQ-YC08N PQ-YC08P PQ-YC08Q	PQ-UE08N PQ-UE08P PQ-UE08Q	PQ-SE08N PQ-SE08P PQ-SE08Q	PQ-MM1008Q	PQ-MA08N PQ-MA08P PQ-MA08Q PQ-MA08W	PQ-BC08P PQ-BC08Q
5/16"	1/8" NPT 1/4" NPT 3/8" NPT	PQ-BT10P PQ-BT10Q	PQ-YC10P PQ-YC10Q	PQ-UE10P PQ-UE10Q PQ-UE10W	PQ-SE10Q PQ-SE10W		PQ-MA10P PQ-MA10Q	PQ-BC10P PQ-BC10Q
8 mm*	M5 R1/8 R1/4 R3/8	PQ-BT08MR PQ-BT08M2 PQ-BT08M3		PQ-UE08MR PQ-UE08M2 PQ-UE08M3				PQ-BC08MR PQ-BC08M2
3/8"	1/8" NPT 1/4" NPT 3/8" NPT	PQ-BT12P PQ-BT12Q PQ-BT12W	PQ-YC12Q PQ-YC12W	PQ-UE12Q PQ-UE12W	PQ-SE12Q PQ-SE12W		PQ-MA12P PQ-MA12Q PQ-MA12W	PQ-BC12Q PQ-BC12W
1/2"	1/4" NPT 3/8" NPT 1/2" NPT		PQ-YC16W PQ-YC16Z		PQ-SE16W PQ-SE16Z		PQ-MA16Q PQ-MA16W PQ-MA16Z	

## Non-Threaded Fittings

									
Tube Size		Straight Union SU	Reduced Union RU	Elbow Union EU	Tee Union TU	Y Union YU	Reduced Branch RB	Cross Union CU	Manifold Union MU**
1/8"		PQ-SU04		PQ-EU04	PQ-TU04	PQ-YU04		PQ-CU04	
5/32"		PQ-SU05	PQ-RU0504	PQ-EU05	PQ-TU05	PQ-YU05	PQ-RB0504	PQ-CU05	PQ-MU0504
6 mm*		PQ-SU06M	PQ-RU06M04M	PQ-EU06M	PQ-TU06M	PQ-YU06M	PQ-RB0805	PQ-CU06M	PQ-MU06M04M
1/4"		PQ-SU08	PQ-RU0804 PQ-RU0805	PQ-EU08	PQ-TU08	PQ-YU08		PQ-CU08	PQ-MU0805
5/16"		PQ-SU10	PQ-RU1008	PQ-EU10	PQ-TU10	PQ-YU10	PQ-RB1008	PQ-CU10	PQ-MU1008
3/8"		PQ-SU12	PQ-RU1208	PQ-EU12	PQ-TU12	PQ-YU12	PQ-RB1208	PQ-CU12	PQ-MU1208
1/2"		PQ-SU16	PQ-RU1612	PQ-EU16	PQ-TU16	PQ-YU16	PQ-RB1612		

\* Fittings have a green release button.

Note: Fittings with pipe thread NPT, R1/8, R1/4 and R3/8 are supplied with pre-applied sealant.



# PUSH-QUICK FITTINGS

## Non-Threaded Fittings

		<b>NEW!</b> 	<b>NEW!</b> 	<b>NEW!</b> 	<b>NEW!</b> 	<b>NEW!</b> 	<b>NEW!</b> 
Tube Size	Bulkhead Union BU	Elbow Reducer ER	Plug-In Elbow PE	Stem Reducer SR	Tube Reducer TR	Stem Coupler SC	Tube Reducer (Stem) TRS
1/8"	PQ-BU04	PQ-ER0405	PQ-PE04	PQ-SR0405		PQ-SC04	
5/32"	PQ-BU05	PQ-ER0508	PQ-PE05	PQ-SR0508	PQ-TR0504	PQ-SC05	PQ-TRS0405
6 mm*	PQ-BU06M						
1/4"	PQ-BU08	PQ-ER0810	PQ-PE08	PQ-SR0810 PQ-SR0812	PQ-TR0805	PQ-SC08	PQ-TRS0508
5/16"	PQ-BU10	PQ-ER1012	PQ-PE10		PQ-TR1008		PQ-TRS0810
3/8"	PQ-BU12	PQ-ER1216	PQ-PE12	PQ-SR1216	PQ-TR1208		PQ-TRS0812
1/2"	PQ-BU16		PQ-PE16		PQ-TR1612		PQ-TRS1216

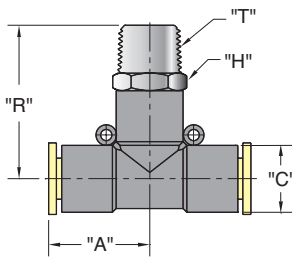

**BT**

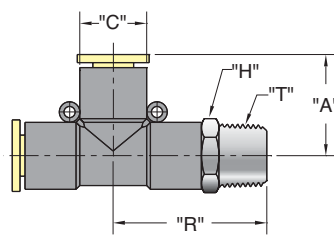

**RT**

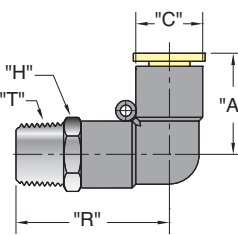

**ME**

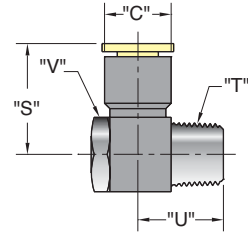

**UE**

Tube Size	Thread Size "T"	"A"	"C"	"H"	"R"	"S"	"U"	"V"
1/8"	#10-32	0.722"	0.410"	7/16"	0.900"			
1/8"	1/8" NPT	0.722"	0.410"	7/16"	0.980"			
5/32"	#10-32	0.722"	0.410"	7/16"	0.900"	0.820"	0.440"	5/16"
5/32"	1/8" NPT	0.722"	0.410"	7/16"	0.980"	0.920"	0.570"	7/16"
5/32"	1/4" NPT	0.722"	0.410"	7/16"	1.130"			
4 mm	M5 x 0.8	0.722"	0.410"	10 mm	0.900"	0.831"	0.449"	8 mm
4 mm	R1/8	0.722"	0.410"	10 mm	0.980"	0.921"	0.563"	10 mm
6 mm	M5 x 0.8	0.830"	0.524"	12 mm	1.030"	0.953"	0.500"	12 mm
6 mm	R1/8	0.830"	0.524"	12 mm	1.100"	0.976"	0.587"	12 mm
6 mm	R1/4	0.830"	0.524"	14 mm	1.140"	1.059"	0.654"	14 mm
1/4"	#10-32	0.840"	0.524"	1/2"	1.030"	0.940"	0.480"	1/2"
1/4"	1/8" NPT	0.840"	0.524"	1/2"	1.100"	0.990"	0.600"	1/2"
1/4"	1/4" NPT	0.840"	0.524"	9/16"	1.230"	1.120"	0.740"	9/16"
1/4"	3/8" NPT	0.840"	0.524"	11/16"	1.290"			
5/16"	1/8" NPT	0.880"	0.580"	9/16"	1.100"	1.120"	0.740"	9/16"
5/16"	1/4" NPT	0.880"	0.580"	9/16"	1.230"	1.120"	0.740"	9/16"
5/16"	3/8" NPT	0.880"	0.580"	11/16"	1.290"	1.120"	0.740"	11/16"
8 mm	M5	0.880"	0.580"	14 mm	1.290"	1.120"	0.740"	14 mm
8 mm	R1/8	0.880"	0.580"	14 mm	1.290"	1.120"	0.740"	14 mm
8 mm	R1/4	0.880"	0.580"	14 mm	1.290"	1.120"	0.740"	14 mm
8 mm	R3/8	0.880"	0.580"	14 mm	1.290"	1.120"	0.740"	14 mm
3/8"	1/8" NPT	1.100"	0.720"	11/16"	1.350"			
3/8"	1/4" NPT	1.100"	0.720"	11/16"	1.470"	1.320"	0.800"	11/16"
3/8"	3/8" NPT	1.100"	0.720"	11/16"	1.160"	1.550"	0.900"	11/16"
1/2"	1/4" NPT	1.160"	0.850"	7/8"	1.550"			
1/2"	3/8" NPT	1.160"	0.850"	7/8"	1.580"			
1/2"	1/2" NPT	1.160"	0.850"	7/8"	1.670"			

# PUSH-QUICK FITTINGS

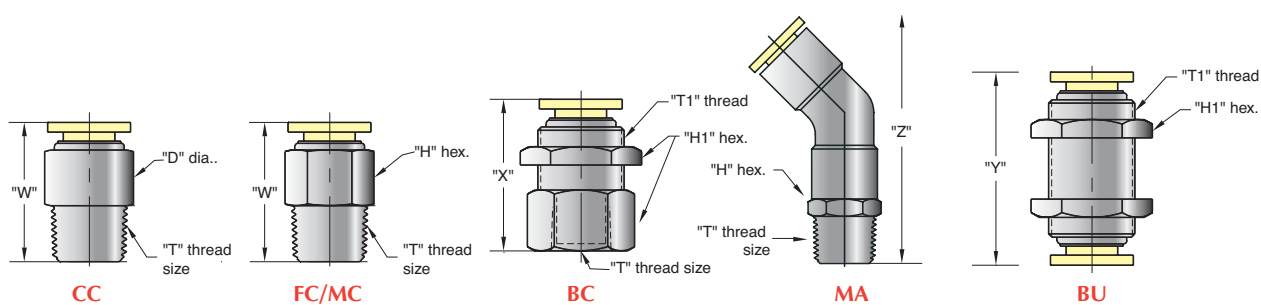

Tubing Size	Thread Size "T"	"D"	"H"	"H1"	"T1"	"W"	"X"	"Y"	"Z"
1/8"	#10-32	0.410"			7/16"	0.880"			1.454"
1/8"	1/8" NPT	0.410"			7/16"	0.860"			1.474"
5/32"	#10-32	0.410"	7/16"		7/16"	0.890"	0.820"	0.440"	1.454"
5/32"	1/8" NPT	0.410"	7/16"	5/8"	7/16"	0.840"	0.920"	0.570"	1.474"
5/32"	1/4" NPT		9/16"			0.920"			
4 mm	M5 x 0.8		10 mm		10 mm	0.900"	0.830"	0.450"	1.454"
4 mm	R1/8		10 mm	14 mm	10 mm	0.840"	0.920"	0.563"	1.474"
6 mm	M5 X 0.8		12 mm		12 mm	0.950"	0.953"	0.500"	1.556"
6 mm	R1/8		10 mm	17 mm	12 mm	0.880"	0.976"	0.587"	1.556"
6 mm	R1/4		14 mm	17 mm	14 mm	0.875"	1.059"	0.654"	1.616"
1/4"	#10-32	0.470"	1/2"		1/2"	0.913"	0.940"	0.480"	1.620"
1/4"	1/8" NPT	0.470"	1/2"	3/4"	1/2"	0.913"	0.990"	0.600"	1.620"
1/4"	1/4" NPT	0.530"	9/16"	3/4"	9/16"	0.965"	1.120"	0.740"	1.682"
1/4"	3/8" NPT		11/16"		11/16"	0.965"			1.722"
5/16"	1/8" NPT	0.550"	9/16"	3/4"		1.09"	1.610"	1.390"	1.800"
5/16"	1/4" NPT	0.550"	9/16"	3/4"	5/8"	1.09"	1.610"	1.390"	1.800"
5/16"	3/8" NPT	0.670"	11/16"	3/4"	5/8"	1.09"	1.610"	1.390"	1.800"
8 mm	M5				5/8"	1.09"	1.610"	1.390"	1.800"
8 mm	R1/8	0.550"	14 mm	19 mm	5/8"	1.09"	1.610"	1.390"	1.800"
8 mm	R1/4	0.550"	14 mm	19 mm	5/8"	1.09"	1.610"	1.390"	1.800"
8 mm	R3/8	0.670"	17 mm	19 mm		1.09"	1.610"	1.390"	1.800"
3/8"	1/8" NPT		11/16"		11/16"	1.280"			1.823"
3/8"	1/4" NPT	0.670"	11/16"	15/16"	11/16"	1.342"	1.320"	0.800"	1.923"
3/8"	3/8" NPT	0.670"	11/16"	15/16"	11/16"	1.241"	1.320"	0.900"	1.943"
1/2"	1/4" NPT		7/8"		7/8"	1.380"			1.965"
1/2"	3/8" NPT		7/8"		7/8"	1.320"			2.125"
1/2"	1/2" NPT		7/8"		7/8"	1.320"			2.195"

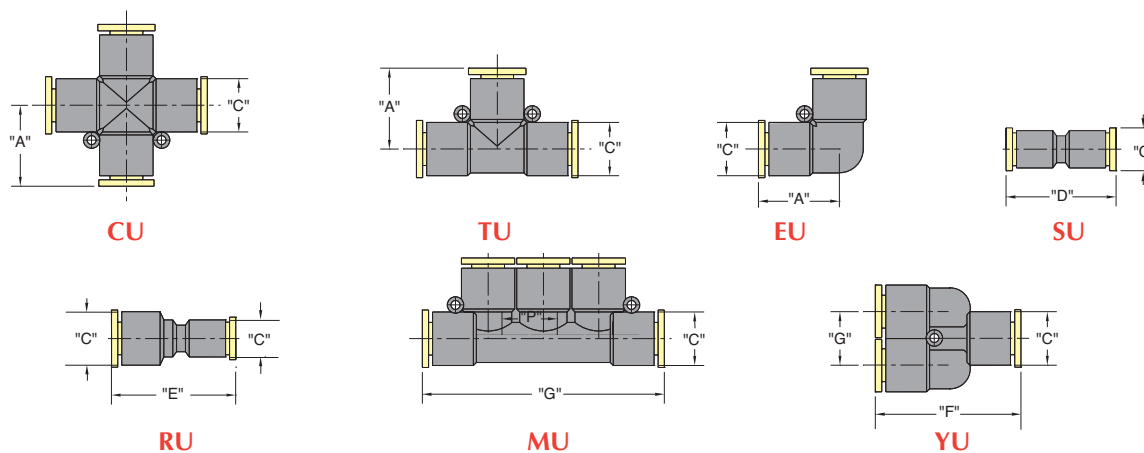

Tubing Size	"A"	"C"	"D"	"E"	"F"	"G"
1/8"	0.710"	0.420"	1.240"			
5/32" / 4 mm	0.722"	0.410"	1.239"	1.230"	1.318"	2.312"
6 mm	0.830"	0.524"	1.500"	1.367"	1.495"	2.435"
1/4"	0.840"	0.524"	1.500"	1.666"	1.495"	2.435"
5/16" / 8 mm	0.880"	0.580"	1.540"	1.540"	1.495"	2.435"
3/8"	1.100"	0.720"	1.851"	1.666"	2.017"	2.312"
1/2"	1.130"	0.850"	1.810"	1.810"	2.070"	