

3-WAY TOGGLE VALVES



3-Way Toggle Valves

3-way valves have a supply, outlet and exhaust port. When the toggle is in the "on" position air flows from the inlet to the outlet and the exhaust port is blocked. Moving the toggle to the "off" position closes the inlet and opens the outlet to an exhaust port which vents the outlet to atmosphere. 3-way toggle valves may have a poppet or spool and by movement

of the toggle may either be 2-position or have a momentary actuation.

Medium: Air

Materials: Brass body, Buna-N seals, stainless steel stem and spring

Stem Travel: 1/8" (3.2)

Mounting: 15/32-32 thd. Nuts and lockwashers furnished

2 Position Spool Valves

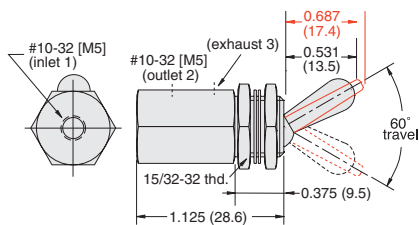

Input Pressure: 150 psig/10 bar max.

Air Flow: 4.5 scfm @ 50 psig; 8.0 scfm @ 100 psig;
190 l/min @ 6 bar

Force For Full Stem Travel: 12 oz. nominal

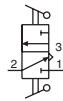

Part No.	Description
TV-3S	2 Position Spool Valve, NP Steel Toggle, #10-32
TV-3S-M5	2 Position Spool Valve, NP Steel Toggle, M5
TV-3SF	2 Position Spool Valve, Plastic Toggle, #10-32
TV-3SF-M5	2 Position Spool Valve, Plastic Toggle, M5

2 Pos. Spool Valve with 1/8" NPT Inlet

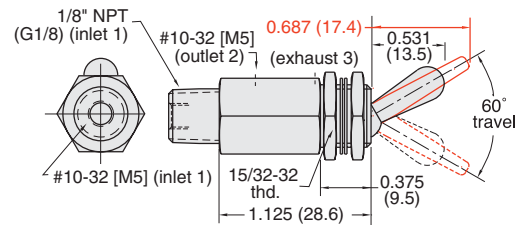

Input Pressure: 150 psig/10 bar max.

Air Flow: 4.5 scfm @ 50 psig; 8.0 scfm @ 100 psig;
190 l/min @ 6 bar

Force For Full Stem Travel: 12 oz. nominal

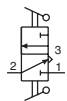

Part No.	Description
TV-3SP	2 Position Spool Valve, NP Steel Toggle
TV-3SFP	2 Position Spool Valve, Plastic Toggle

2 Position Poppet Valves

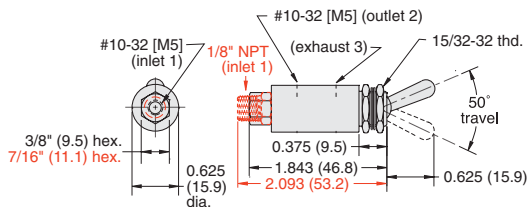

Input Pressure: 150 psig/10 bar max.

Air Flow: 4.0 scfm @ 50 psig; 6.8 scfm @ 100 psig;
175 l/min @ 6 bar

Force For Full Stem Travel: 16 oz. nominal

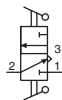

Part No.	Description
MTV-3	2 Position Poppet Valve, #10-32, NP Brass Toggle
MTV-3-M5	2 Position Poppet Valve, M5, NP Brass Toggle
MTV-3P	2 Position Poppet Valve, 1/8" NPT, NP Brass Toggle

2 Pos. N.C. Poppet with Momentary Actuation

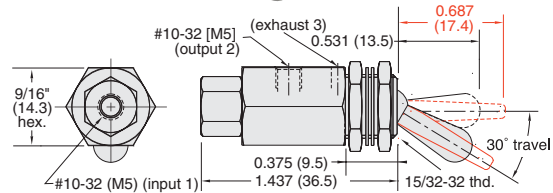

Input Pressure: 150 psig/10 bar max.

Air Flow: 4.0 scfm @ 50 psig; 6.8 scfm @ 100 psig;
175 l/min @ 6 bar

Force For Full Stem Travel: 12 oz. nominal



Part No.	Description
TV-3M	2 Position Poppet Valve, NP Steel Toggle, #10-32
TV-3M-M5	2 Position Poppet Valve, NP Steel Toggle, M5
TV-3MF	2 Position Poppet Valve, Plastic Toggle, #10-32
TV-3MF-M5	2 Position Poppet Valve, Plastic Toggle, M5



3-WAY TOGGLE VALVES

2 Pos. N.C. Poppet w/Momentary Actuation

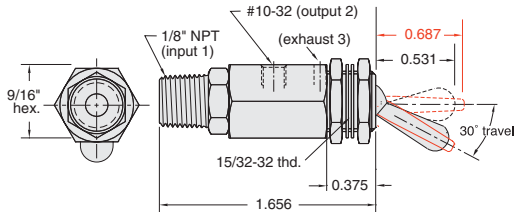
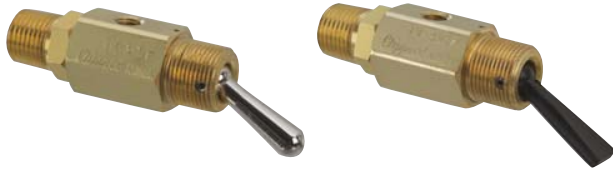

Input Pressure: 300 psig max.

Air Flow: 4.0 scfm @ 50 psig; 6.8 scfm @ 100 psig

Force For Full Stem Travel: 12 oz. nominal



Part No.	Description
TV-3MP	2 Position Poppet Valve, NP Steel Toggle
TV-3MFP	2 Position Poppet Valve, Plastic Toggle

2 Pos. N.O. Poppet w/Momentary Actuation

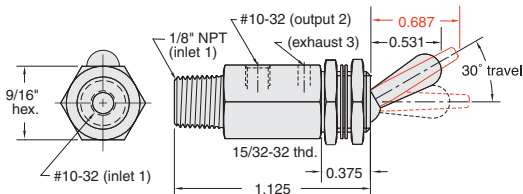

Input Pressure: 150 psig max.

Air Flow: 4.0 scfm @ 50 psig; 6.8 scfm @ 100 psig

Force For Full Stem Travel: 12 oz. nominal



Order Information	
TVO-3MP	2 Position Spool Valve, NP Steel Toggle
TVO-3MFP	2 Position Spool Valve, Plastic Toggle

2 Pos. N.O. Poppet w/Momentary Actuation

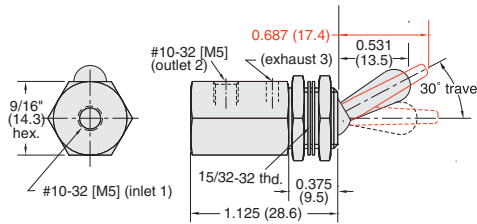

Input Pressure: 150 psig/10 bar max.

Air Flow: 4.0 scfm @ 50 psig; 6.8 scfm @ 100 psig;
170 lpm @ 6 bar

Force For Full Stem Travel: 12 oz. nominal

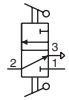

Part No.	Description
TVO-3M	2 Position Spool Valve, NP Steel Toggle, #10-32
TVO-3M-M5	2 Position Spool Valve, NP Steel Toggle, M5
TVO-3MF	2 Position Spool Valve, Plastic Toggle, #10-32
TVO-3MF-M5	2 Position Spool Valve, Plastic Toggle, M5

2 Position Poppet Valves

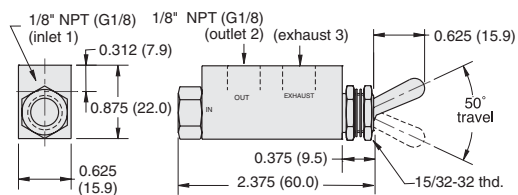

Input Pressure: 300 psig/21 bar max.

Air Flow: 14 scfm @ 50 psig; 25 scfm @ 100 psig;
600 l/min @ 6 bar

Force For Full Stem Travel: 16 oz. nominal

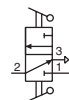

Part No.	Description
MJTV-3	2 Position Poppet Valve, 1/8" NPT
MJTV-3-MG	2 Position Poppet Valve, G1/8

15/32 Panel Mounting Nut



Brass with black or bright nickel finish

Part No.	
11406-1	Black
11406-2	Bright

3-WAY TOGGLE & STEM VALVES



2 Position Spool Valves

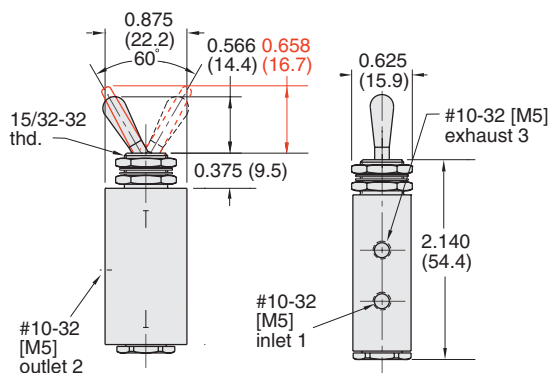

Input Pressure: 150 psig/10 bar max.

Air Flow: 6 scfm @ 50 psig; 10 scfm @ 100 psig;
280 l/min @ 6 bar

Force For Full Stem Travel: 16 oz. nominal

Mounting: 15/32-32 thread. Nuts and lockwashers furnished.

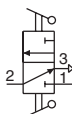

Part No.	Description
FTV-3	2 Position Spool Valve, NP Steel Toggle, #10-32
FTV-3-M5	2 Position Spool Valve, NP Steel Toggle, M5
FTV-3F	2 Position Spool Valve, Plastic Toggle, #10-32
FTV-3F-M5	2 Position Spool Valve, Plastic Toggle, M5

2 Position Spool Valves

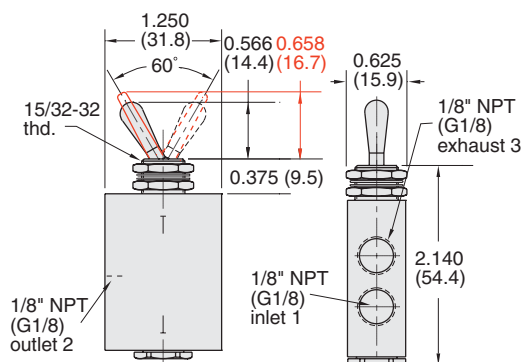
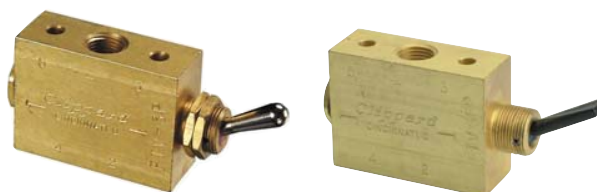

Input Pressure: Vacuum to 150 psig/10 bar max.

Air Flow: 6.5 scfm @ 50 psig; 10.5 scfm @ 100 psig;
290 l/min @ 6 bar

Force For Full Stem Travel: 16 oz. nominal

Mounting: 15/32-32 thread. Nuts and lockwashers furnished.

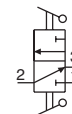

Part No.	Description
FTV-3P	2 Position Spool Valve, NP Steel Toggle, 1/8" NPT
FTV-3-MG	2 Position Spool Valve, NP Steel Toggle, G1/8
FTV-3FP	2 Position Spool Valve, Plastic Toggle, 1/8" NPT
FTV-3F-MG	2 Position Spool Valve, Plastic Toggle, G1/8

Sub-Miniature Spool Valve

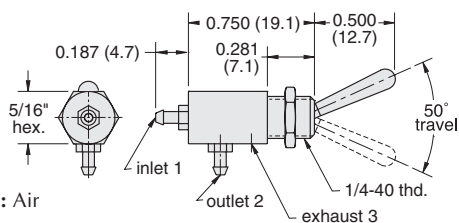

Medium: Air

Input Pressure: 100 psig max.

Ports: 3-56 with 1/16" ID Hose Barbs

Air Flow: 1.4 scfm @ 100 psig

Force For Full Stem Travel: 24 oz. nominal

Spool Material: Delrin®

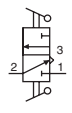

Part No.	Description
SMTV-3	Sub-Miniature Spool Valve

Sub-Mini. N.O. or N.C. Spool Valve

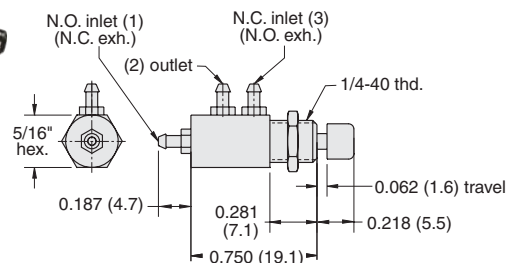

Medium: Air

Stem Travel: 1/16"

Input Pressure: 100 psig max.

Ports: 3-56 with 1/16" ID Hose Barbs

Air Flow: 1.4 scfm @ 100 psig

Force For Full Stem Travel: 20 oz. nominal

Spool Material: Delrin®

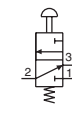

Part No.	Description
SMAV-3	Sub-Miniature N.O. or N.C.