

IMPERIAL

Compression (%)	15.0	20.0	22.5	25.0	27.5
Load (lbs.)	400	595	685	800	900
Height (in.)	4.3	4.0	3.9	3.8	3.6
Rate (lbs./in.)	716	790	822	852	880
Effective Deflection (in.)	0.6	0.8	0.8	0.9	1.0
Natural Freq. (CPM)	252	217	206	194	186
Maximum OD (in.)	4.1				
Weight (lbs.)	1.22				

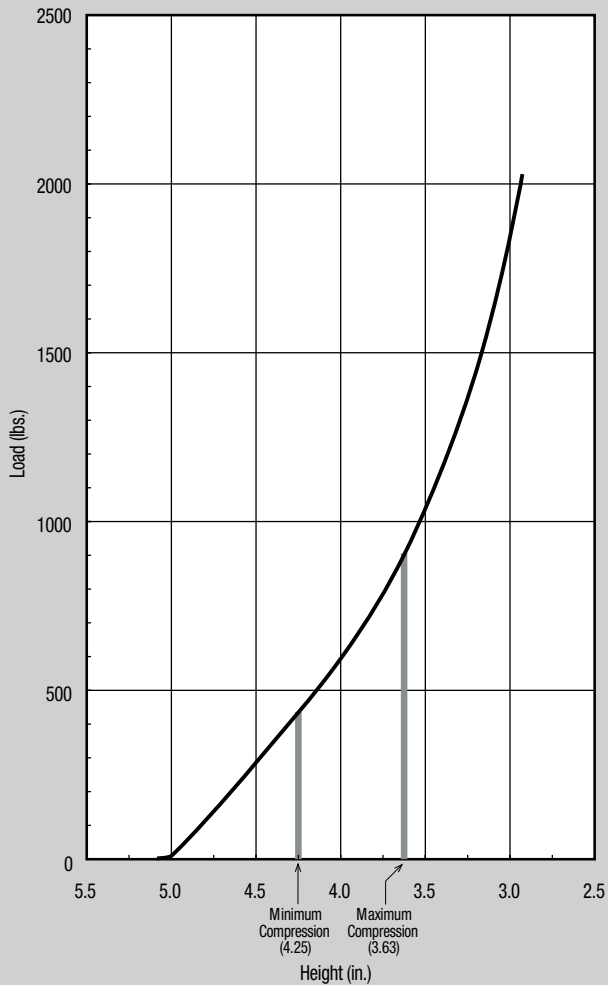
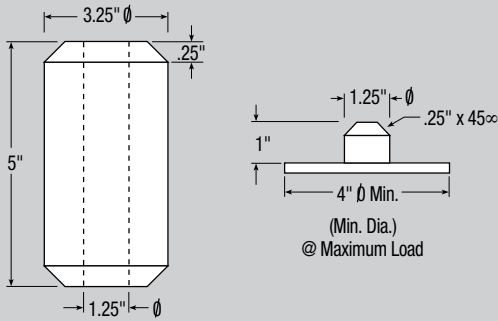

METRIC

Compression (%)	15.0	20.0	22.5	25.0	27.5
Load (kN)	1.78	2.64	3.04	3.56	4.00
Height (mm)	109	102	99	97	91
Rate (kN/m)	125	138	144	149	154
Effective Deflection (mm)	15	20	20	23	25
Natural Freq. (Hz)	4.20	3.62	3.43	3.23	3.10
Maximum OD (mm)	104				
Weight (kg)	0.56				

